

PROJECT	QUANTITY	ITEM NO
---------	----------	---------

SmartHold® holding cabinet

MODEL **HHC-990** full-size



HHC-990 *SmartHold* full-size holding cabinet with recessed water pan, 5-inch (127 mm) casters. Holds up to 15 full-size sheet pans.

General Information

Henny Penny *SmartHold*® humidified holding cabinets are designed to hold a wide range of foods within ideal temperature and humidity conditions for long periods of time prior to serving.

The *SmartHold* patented automatic humidity control system links water pan heat, fans and ventilation in a closed loop control that lets foodservice operators measure and maintain precise humidity levels in one-percent increments from 10 to 90% relative humidity.

This extraordinary humidity control means you can hold practically any type of food for exceptionally long periods of time without sacrificing freshness or presentation. That translates into higher food quality and less waste throughout the day.

The *SmartHold* holding cabinets also improve your equipment and labor utilization. With longer holding

periods, operators can cook in quantity before peak periods and stock heated display cases directly from the holding cabinet. Some items, such as slow-cooked ribs, can be held overnight, a process that actually improves the flavor and further tenderizes the meat.

SmartHold humidified holding cabinets also feature a Proofing Mode with lower holding temperatures of 80-140°F (27-60°C). By proofing and holding in the same cabinet, you can use the HHC-990 all day long and eliminate the need for a separate proofing cabinet.

Additional standard features such as fully insulated doors and cabinet walls, quick-response humidity generation, compatible racking system and self-closing doors help protect food quality, reduce waste and provide for more efficient workflow.

Standard Features

- Durable, high-quality stainless steel construction, interior and exterior.
- Patented closed loop humidity control:
 - Maintain any humidity level between 10 and 90% RH.
 - Exclusive automatic venting.
 - Self-diagnostic for vent motor, temperature sensor and water pan heater operation.
 - Easy to clean and service.
- Programmable count down timers with single switch start/stop/abort, manual override and power-out memory.
- Constant digital humidity/temperature display.
- Separate humidity/temperature set points.
- Low water warning light.
- Sound alert signal.
- Food probe temperature display.
- Large 3-gallon (11.4 liters) stainless steel recessed heated water pan.
- Proofing mode.
- Quick-response humidity generation.
- Fully insulated doors, sidewalls and control module.
- Full perimeter door gasket.
- Self-closing, lift-off doors stay open past 90 degrees.
- Magnetic door latch and heavy-duty plated hinges.
- 4 casters 5 in. (127 mm), 2 locking.
- Optional hose drain connection.

Please specify desired configuration

- Count down timers
 5 OR 15
- Door hinge
 Right OR Left
- Shelf runners (see back)
 10 13 15
- Style
 Pass-through OR solid back

<input type="checkbox"/> APPROVED	<input type="checkbox"/> APPROVED AS NOTED	<input type="checkbox"/> RESUBMIT
AUTHORIZED SIGNATURE		DATE

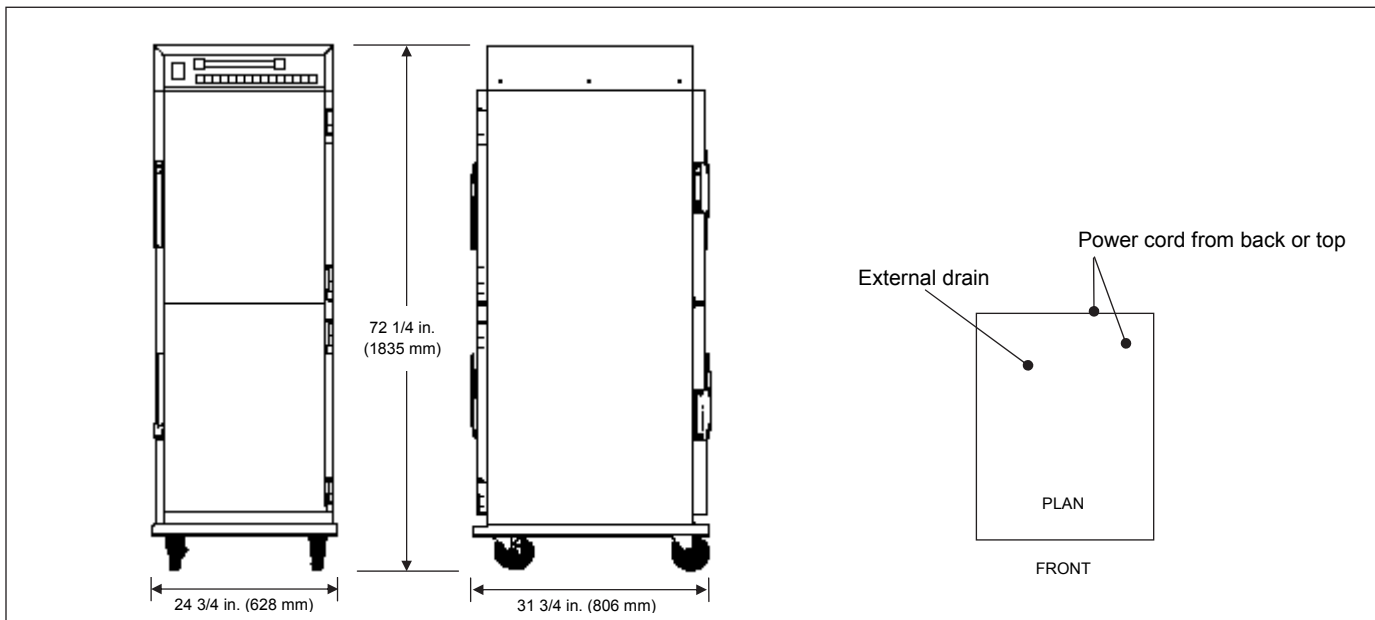

SmartHold® holding cabinetMODEL **HHC-990** full-size**Dimensions**

Height: 72 1/4 in. (1835 mm)
 Width: 24 3/4 in. (628 mm)
 Depth: 31 3/4 in. (806 mm)

Required clearances: N/A**Crated dimensions**

Length: 74 3/4 in. (1900 mm)
 Depth: 35 1/2 in. (900 mm)
 Height: 31 in. (790 mm)
 Volume: 46 cu. ft. (1.35 m³)

Crated weight: 367 lbs. (167 kg)**Water connections**

3 gallon (11.4 liters) water pan, 2 gallons (7.6 liters) for operational use.
 External drain connection.

Heating







Proofing mode: 80-140°F (27-60°C)
 Normal holding: 160-210°F (71-99°C)

Humidity: OFF/ON 10-90% RH**Pan capacity**

Accepts standard sheet pans 18 x 26 in. (457 x 660 mm). Please specify one of the following configurations when ordering:

- 10 pans on 4 7/8 in. (124 mm) centers OR
- 13 pans on 3 3/4 in. (95 mm) centers OR
- 15 pans on 3 1/4 in. (83 mm) centers

Electrical

Volts	Phase	Cycle/Hz	Watts	Amps	Wire	Plug type (optional)	
120	1	60	2680 or 2880	22.3 – 24.0	2+G	NEMA 5-30P	NEMA 5-50P
200	1	50/60	2649	13.2	2+G		
208	1	60	2880	13.8	2+G		
220-240	1	50/60	2792	11.6	1NG	NEMA 6-15P	NEMA 6-20P
240	1	50/60	2676 or 2876	11.2 – 12.0	2+G		

Optional power cord and plug supplied for USA and Canada, only.

Laboratory certifications**Bidding Specifications**

- Provide Henny Penny Model HHC-990 full-size *SmartHold* Humidified Holding Cabinet. Units are designed to provide ideal environment for safely holding a wide variety of hot foods in quality condition for very long periods of time.
- Unit features a patented closed loop control system to regulate precise temperatures and humidity levels.
- Unit shall have Proofing Mode, a lower temperature range setting.
- Unit shall be of 300 grade stainless steel construction throughout.
- Provide choice of 5 or 15 count-down timers.
- Provide choice of right or left-hand doors, solid back or pass-through design.
- Provide choice of racking configurations for 10, 13 or 15 pans.
- Unit shall include recessed 3 gal. (11.4 liters) stainless steel water pan.
- Unit shall have full perimeter door gasket and fully insulated sidewalls and control module.
- Unit shall have 2 heavy-duty blower motors and ventilated side racks.
- Unit shall be equipped with 4 casters 5 in. (127 mm), 2 are locking.

Continuing product improvement may subject specifications to change without notice.

Henny Penny Corporation
 PO Box 60 Eaton OH 45320 USA

+1 937 456.8400 800 417.8417
 +1 937 456.8434 Fax 800 417.8434 Fax

www.hennypenny.com

HENNY PENNY